

INOVA

STEEL DIŐ TİCARET CO. LTD.

CATALOG

Turkey's

Global Iron and Steel Supplier

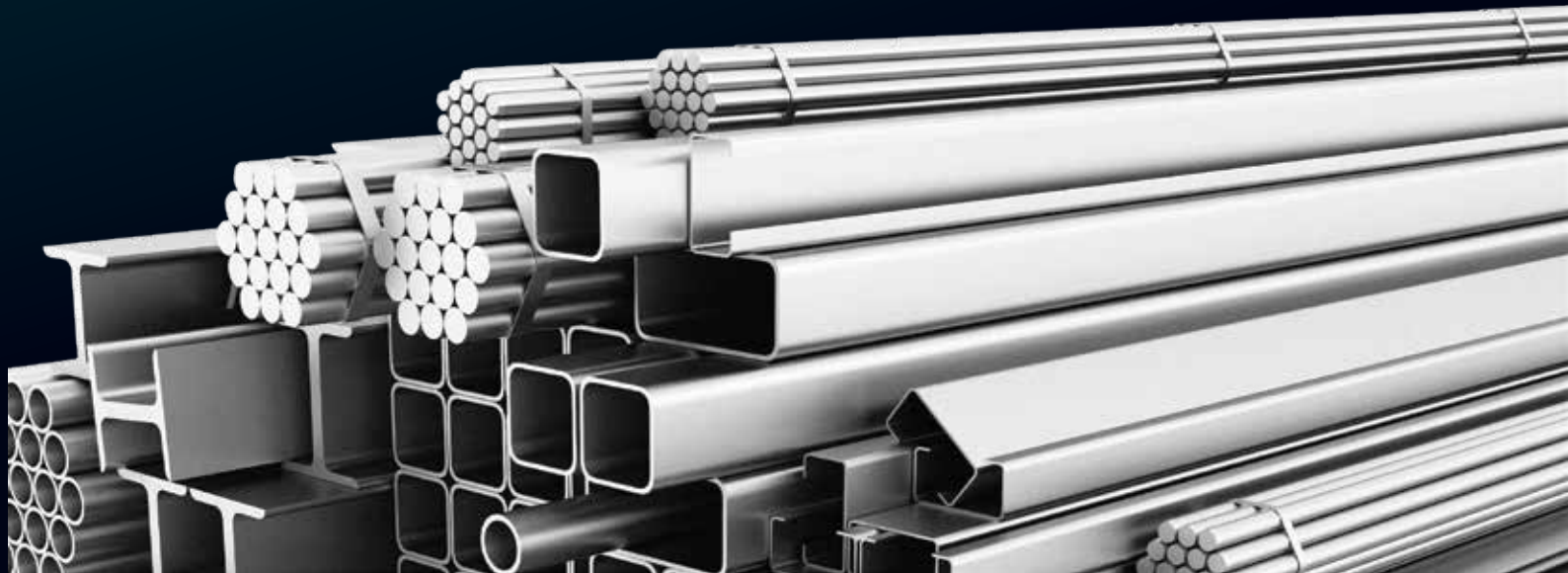



HIGH
QUALITY
IRON AND
STEEL
PRODUCTS

About US

Inova Steel is Turkey's Global Steel and Iron supplier with ISO-9001, ISO-14001 - ISO 45001 - ISO 10002 certifications.

Our Products

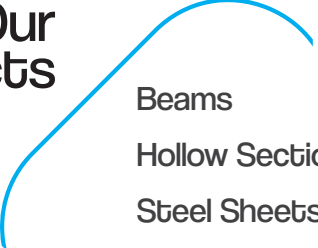

- Beams
- Hollow Section & Pipes
- Steel Sheets (HRC)
- Cold Rolled Sheets, galvanized sheet
- Plates
- Checkered pattern and eardrop pattern sheets
- Corten -(weathering steel)
- Stretch resistant sheets(MC quality)
- Wear resistant sheets
- Boiler sheets
- Wire Rod
- All long and flat steel products

We Are Offering

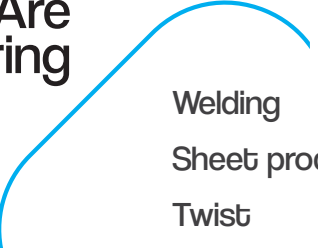

- Welding
- Sheet processing
- Twist
- Sandblasting
- Painting
- Cutting
- Eccentric press
- Cut-to-length
- Stirrup, miter, circular

HEA BEAMS

SIZE
100-1000 mm

LENGTH
6-15 m

DIMENSIONS
EN 10365

TOLERANCES
EN 10034



HEB BEAMS

SIZE
100-1000 mm

LENGTH
6-15 m

DIMENSIONS
EN 10365

TOLERANCES
EN 10034



HEM BEAMS

SIZE
100-1000 mm

LENGTH
6-15 m

DIMENSIONS
EN 10365

TOLERANCES
EN 10034



IPE BEAMS

SIZE
100-600 mm

LENGTH
6-15 m

DIMENSIONS
EN 10365

TOLERANCES
EN 10034



IPN BEAMS

SIZE
80-400 mm

LENGTH
6-15 m

DIMENSIONS
EN 10365

TOLERANCES
EN 10024

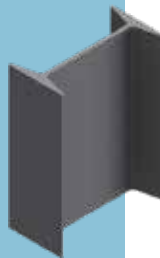

UPN BEAMS

SIZE
65-400 mm

LENGTH
6-15 m

DIMENSIONS
EN 10365

TOLERANCES
EN 10279

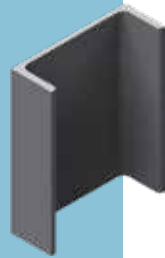

UB BEAMS

SIZE
100-300 mm

LENGTH
6-15 m

DIMENSIONS
BS 41

TOLERANCES
EN 10034



UC BEAMS

SIZE
100-200 mm

LENGTH
6-15 m

DIMENSIONS
BS 41

TOLERANCES
EN 10034

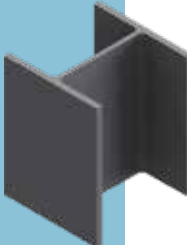

W BEAMS

SIZE
100-300 mm

LENGTH
6-15 m

DIMENSIONS
ASTM A6

TOLERANCES
ASTM A6



T IRON BARS

SIZE
20-140 mm

LENGTH
6-15 m

DIMENSIONS
ASTM A36

TOLERANCES
EN 10034

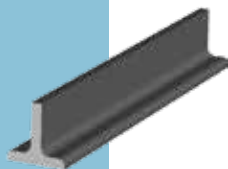

ANGLE BARS

SIZE
20-250 mm

LENGTH
6-15 m

DIMENSIONS
EN 10056-1

TOLERANCES
EN 10056-2



PFC BEAMS

SIZE
80-300 mm

LENGTH
6-15 m

DIMENSIONS
BS 41

TOLERANCES
EN 10279

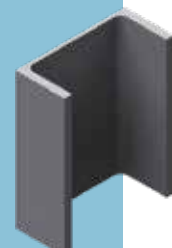

FLAT BARS

WIDTH
10-250 mm

THICKNESS
3-50 mm

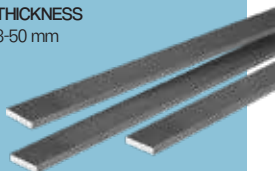

SQUARE BARS

THICKNESS
8-250 mm

TOLERANCES
EN 10059

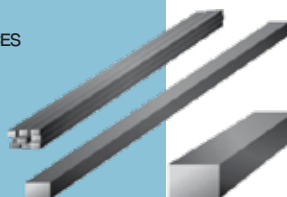

WIRE ROD

SIZE
5.5-25 mm

WEIGHT
2050-2400 KG.

OUTSIDE DIAMETER
1250 mm

INTERNAL DIAMETER
850 mm



Long Steel Products

We manufacture our products in accordance with S235J0 - S235JR - S235J2 (ST37), S275J0 - S275JR - S275J2 (ST44), S355J0 - S355JR-S355J2 (ST52) quality and international quality standards, including Russian GOST 380-94, German DIN 17100, UK BS 4360, and European EN 10025.



Sheets and Plates

ROLLED SHEET

THICKNESS
1225 mm

DIMENSIONS
1000 x 2000
2000 x 12000



DKP SHEET

THICKNESS
0.4-3 mm

ROLLED WIDTH
1000, 1200, 1250,
1500

PACKAGE
1000 x 2000
1250 x 2500



GALVANIZED SHEET

THICKNESS
0.4-4 mm

WIDTH
550-1500 mm

COATING THICKNESS
122-350 gr/m²



PACKAGE SHEET

THICKNESS
1225 mm

WIDTH
500-15000 mm



BOILER SHEET

WIDTH
1500-3000 mm

WALL THICKNESS
5-60 mm



CORTEN weathering steel

THICKNESS
1-20 mm

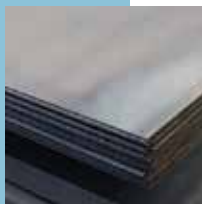

PLATE SHEET

THICKNESS
5-200 mm

WIDTH
1500-4000 mm

LENGTH
6000-12000 mm



WEAR RESISTANT STEEL

SIZE
2-120 mm

HB400
HB450
HB500
HB550
HB600

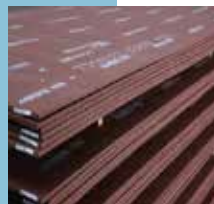

FLEX RESISTANT STEEL

2-120 mm

HB400
HB450
HB500



ARMOR STEEL

PROTECTION 280 T
THICKNESS : 4.00-25.40 MM
HARDNESS : 270-330 HBW

PROTECTION 440 T
THICKNESS : 4.00-20.40 MM
HARDNESS : 420-480 HBW

PROTECTION 500 T
THICKNESS : 4.00-24.00 MM
HARDNESS : 420-480 HBW

PROTECTION 600 T
THICKNESS : 4.00-20.00 MM
HARDNESS : 570-650 HBW



FOR MORE INFORMATION
PLEASE VISIT OUR WEB SITE
www.inovasteel.com.tr

C



C Perforated



Sigma



Sigma Perforated



U



U Perforated



C Plus



C Plus Perforated



Sigma Plus



Sigma Plus Perforated



Z



Z Perforated



Sheets and Plates

We manufacture our products in accordance with S235J0 - S235JR - S235J2 (ST37), S275J0 - S275JR - S275J2 (ST44), S355J0 - S355JR-S355J2 (ST52) quality and international quality standards, including Russian GOST 380-94, German DIN 17100, UK BS 4360, and European EN 10025.



Hollow Section and Pipes

We manufacture our products in accordance with S235J0 - S235JR - S235J2 (ST37), S275J0 - S275JR - S275J2 (ST44), S355J0 - S355JR-S355J2 (ST52) quality and international quality standards, including Russian GOST 380-94, German DIN 17100, UK BS 4360, and European EN 10025.



Hollow Section and Pipes

Hollow Section

PRIMER COATED SQUARE STEEL

OUTSIDE
DIAMETER
10X10
250X250 mm

WALL
THICKNESS
0,70-10,0 mm

LENGTH
4,0-14,0 m



PRIMER COATED RECTANGLE STEEL

OUTSIDE
DIAMETER
10X15
200X300 mm

WALL
THICKNESS
0,70-10,0 mm

LENGTH
4,0-14,0 m



RECTANGULAR STEEL

OUTSIDE
DIAMETER
10X15
200X300 mm

WALL
THICKNESS
0,90-10,0 mm

LENGTH
4,0-14,0 m

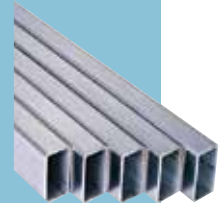

SQUARE STEEL

OUTSIDE
DIAMETER
10X10
250X250 mm

WALL
THICKNESS
0,90-10,0 mm

LENGTH
4,0-14,0 m

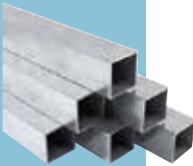

SQUARE GALVANIZED STEEL

DIMENSIONS
10X15
200X200 mm

WALL
THICKNESS
0,60-12,5 mm

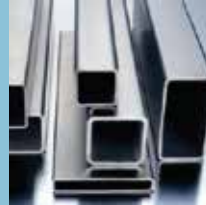

RECTANGULAR GALVANIZED STEEL

DIMENSIONS
10X20
200X300 mm

WALL
THICKNESS
0,60-10,0 mm



PRODUCTION STANDARTS

EN 10219 (TS EN 10219) (CE)

SI 1458-1

ASTM A500

EN 10305-5 (TS EN 10305-3)

AS/NZS 1163

STEEL GRADES

S235JRH, S275J0H, S275J2H, S355J0H
S355J2H, S355K2H, S275NH, S275NLH,
S275MH, S275MLH, S355NH, S355NJH,
S355MH, S355MLH, S420MH, S420MLH.

S235JRH, S275J0H, S275J2H, S355J0H
S355J2H, S355K2H, S275NH, S275NLH,
S275MH, S275MLH, S355NH, S355NJH,
S355MH, S355MLH, S420MH, S420MLH.

Grade A, Grade B, Grade C, Grade D.

E155, E190, E195, E220, E235, E260, E275,
E320, E355, E370, E420

C250, C350, C450, C250L0, C350L0

Hollow Section and Pipes

Pipes

GALVANIZED PIPES

OUTSIDE
DIAMETER
213-2911 mm

WALL
THICKNESS
18-711 mm

LENGTH
5-8,5 m

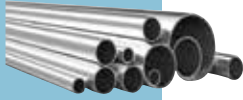

INDUSTRIAL PIPES

OUTSIDE
DIAMETER
130-339,7 mm

WALL
THICKNESS
0,90-13,0 mm

LENGTH
4,0-14,0 m



BOILER PIPES

OUTSIDE
DIAMETER
213-339,7 mm
(1/2"-13 3/8")

WALL
THICKNESS
2,6-13,0 mm

LENGTH
4,0-14,0 m



PRIMER COATED PIPES

OUTSIDE
DIAMETER
130-339,7 mm

WALL
THICKNESS
0,70-13,0 mm

LENGTH
4,0-14,0 m



SCAFFOLDING PIPES

OUTER
DIAMETER
26,9-76,1 mm

WALL
THICKNESS
2,0-6,0 mm

LENGT
4,0-14,0 m



PRODUCTION STANDARTS

EN 39 (TS 8481 EN 39)

EN 10219 (TS EN 10219) (CE)

STEEL GRADES

S 235 GT

S235JRH, S275J0H, S275J2H, S355J0H
S355J2H, S355K2H, S275NH, S275NLH,
S275MH, S275MLH, S355NH, S355NJH,
S355MH, S355MLH, S420MH, S420MLH.



FOR MORE INFORMATION
PLEASE VISIT OUR WEB SITE

www.inovasteel.com.tr

Special Shaped Hollow Section

**OVAL
PROFILES**

OUTSIDE
DIAMETER
30x15
50x32 mm

WALL
THICKNESS
0.50-3

LENGTH
4-8.5 m

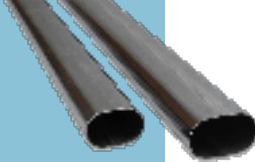

**ELLIPTICAL
PROFILE**

OUTSIDE
DIAMETER
40x20 mm

WALL
THICKNESS
0.6-3.0 mm

LENGTH
4-8, 0m

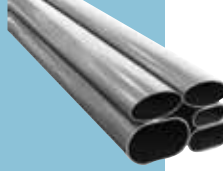

D-PROFILE

OUTSIDE
DIAMETER
40x30 mm

WALL
THICKNESS
0.80-3.0 mm

LENGTH
4-8 m

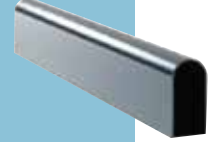

L T Z PROFILE

OUTSIDE
DIAMETER
28-33 mm

WALL
THICKNESS
1.20-3 mm

LENGTH
4-8.5 m

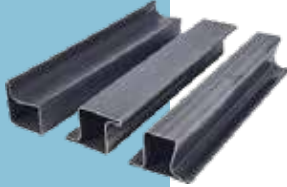

PRODUCTION STANDARTS

EN 10219 (TS EN 10219) (CE)

EN 10305-5 (TS EN 10305-5)

STEEL GRADES

S235JRH, S275J0H, S275J2H, S355J0H
S355J2H, S355K2H, S275NH, S275NLH,
S275MH, S275MLH, S355NH, S355NJH,
S355MH, S355MLH, S420MH, S420MLH.

E155, E190, E195, E220, E235, E260, E275,
E320, E355, E370, E420



FOR MORE INFORMATION
PLEASE VISIT OUR WEB SITE

www.inovasteel.com.tr

Crane Rails

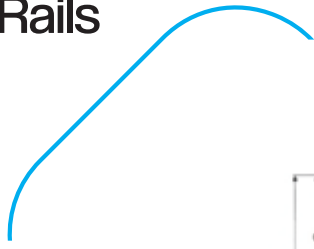

A 45 Crane Rails

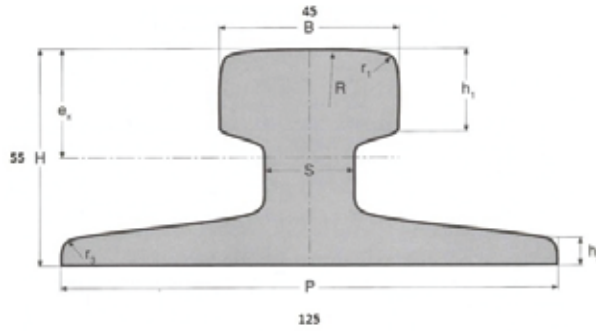

Designation	Weight		B	S	P	H	R	h ₁	h ₂	r ₁	r ₂	r ₃	e _x
	Kg/m	Lbs/yd											
A 45	22,1	44,55	45	24	125	55	400	20,0	8	4	4	33,3	

A 55 Crane Rails

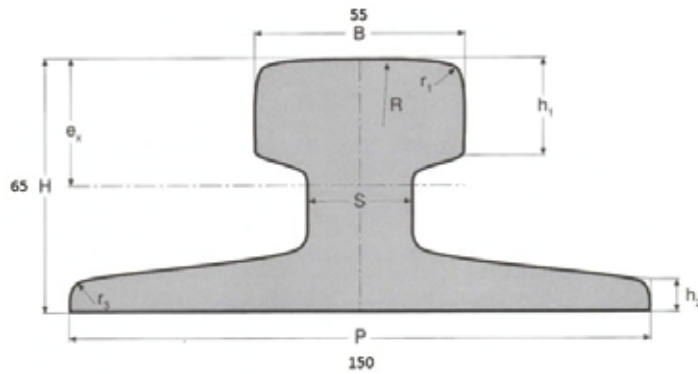

Designation	Weight		B	S	P	H	R	h ₁	h ₂	r ₁	r ₂	r ₃	e _x
	Kg/m	Lbs/yd											
A 55	31,8	64,11	55	31	150	65	400	25,0	9	5	5	39,0	

A 65 Crane Rails

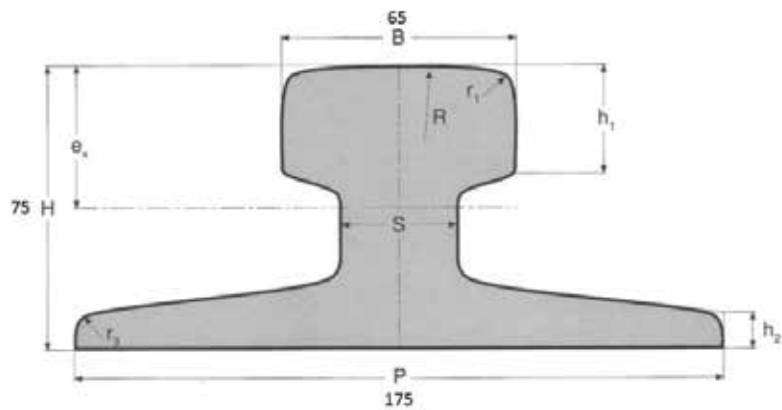

Designation	Weight		B	S	P	H	R	h ₁	h ₂	r ₁	r ₂	r ₃	e _x
	Kg/m	Lbs/yd											
A 65	43,1	86,89	65	38	175	75	400	30,0	10	6	5	44,7	

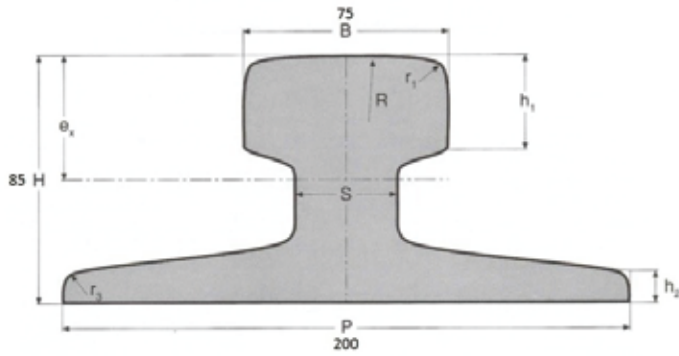

A 75 Crane Rails

Designation	Weight		B	S	P	H	R	h ₁	H ₂	r ₁	r ₂	e _x
	Kg/m	Lbs/yd										
A 75	56,2	113,29	75	45	200	85	500	35,0	11	8	6	50,4

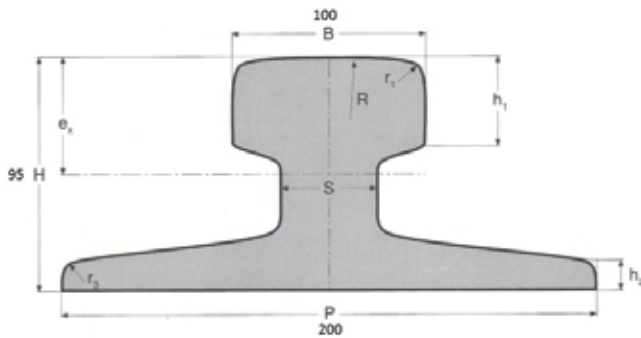

A 100 Crane Rails

Designation	Weight		B	S	P	H	R	h ₁	H ₂	r ₁	r ₂	e _x
	Kg/m	Lbs/yd										
A 100	74,3	149,78	100	60	200	95	500	40,0	12	10	6	52,9

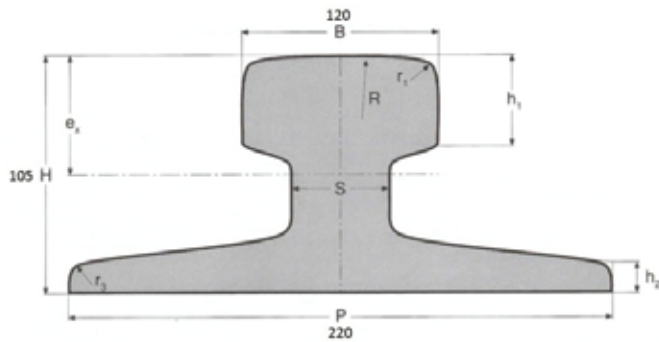

A 120 Crane Rails

Designation	Weight		B	S	P	H	R	h ₁	H ₂	r ₁	r ₂	e _x
	Kg/m	Lbs/yd										
A 120	100,0	201,59	120	72	220	105	600	47,5	14	10	6	57,9

A 150 Crane Rails

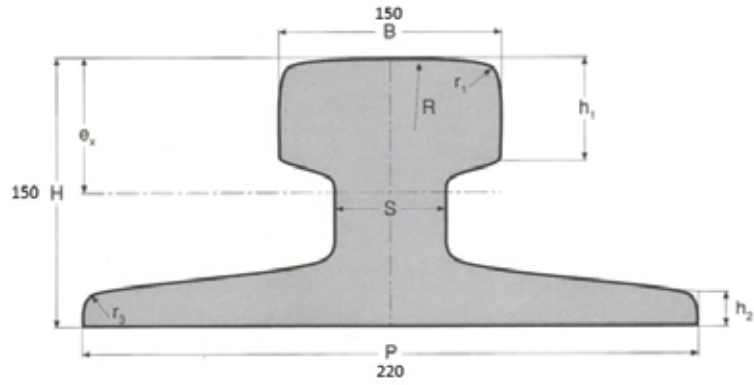

Designation	Weight		B	S	P	H	R	h ₁	H ₂	r ₁	r ₂	e _x
	Kg/m	Lbs/yd										
A 150	150.3	302.99	150	80	220	150	800	50.0	14	10	6	77.3

S 10 Crane Rails

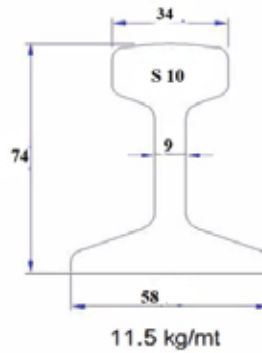

Rail Type	H mm	B1 mm	B2 mm	S mm
S 10	74	34	58	9

S 12 Crane Rails

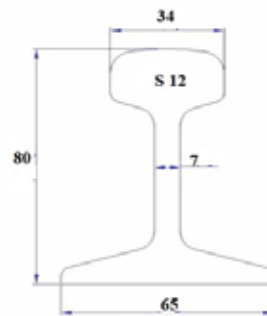

Rail Type	H mm	B1 mm	B2 mm	S mm
S 12	80	34	65	7

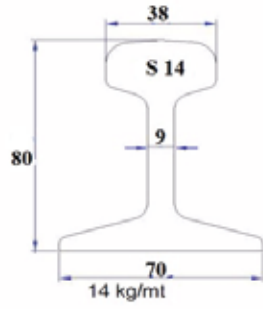

S 14 Crane Rails

Rail Type	H mm	B1 mm	B2 mm	S mm
S 14	80	38	70	9

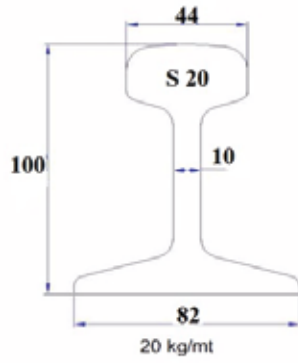

S 20 Crane Rails

Rail Type	H mm	B1 mm	B2 mm	S mm
S 20	100	44	82	10





T.C.
TÜRK PATENT ve MARKA KURUMU

MARKA TESCİL BELGESİ

Marka No : 2021 131821 - Ticaret - Hizmet

INOVA
STEEL

Marka Sahibi : INOVA STEEL BİYO TİCARET LİMİTED ŞİRKETİ
TÜRKİYE CUMHURİYETİ
KÜÇÜK ÇİĞLİ MAH. 87181 SK. 72 Çift İskele
Emlak : 06
İlişiktir.



İşbu Marka 21/09/2021 tarihinden itibaren ON YIL süreyle
23/03/2022 tarihinde tescil edilmiştir.

Prof. Dr. Habip ASAN
Türk Patent ve Marka
Kurumu Başkanı

**TURK
PATENT**



T.C.
TÜRK PATENT ve MARKA KURUMU

MARKA TESCİL BELGESİ

Marka No : 2021 131821 - Ticaret - Hizmet

INOVA
STEEL

Marka Sahibi : INOVA STEEL BİYO TİCARET LİMİTED ŞİRKETİ
TÜRKİYE CUMHURİYETİ
KÜÇÜK ÇİĞLİ MAH. 87181 SK. 72 Çift İskele
Emlak : 06
İlişiktir.



İşbu Marka 21/09/2021 tarihinden itibaren ON YIL süreyle
23/03/2022 tarihinde tescil edilmiştir.

Prof. Dr. Habip ASAN
Türk Patent ve Marka
Kurumu Başkanı

**TURK
PATENT**

CERTIFICATE



Bu Sertifika / This certificate is granted to the organization



INOVA STEEL DIŞ TİCARET LİMİTED ŞİRKETİ

Kılıçlı Çift Mah. 8738/3. Sokak No: 7 İç Kapı No: 2 Çifti / İzmir / Türkiye

KIOSCERT Belgelendirme tarafından denetlenmiş ve uygulanmakta olduğu Çeşitli Yönetim Sistemleri
Is audited by KIOSCERT Certification and applied
Environmental Management System meet the requirements of

ISO 14001:2015

standartlarına aşağıdaki kapsamda uymakta olduğu görülmüştür.
Standard for the following activities:

Belgelendirme Kapsamı / Certification Scope

DEMİR-ÇELİK YARI MAMÜL VE MAMÜLLERİN TEMİN EDİLMESİ, ALIMI, SATIMI, BU FAALİYETLERE İLİŞKİN GÜMRÜK, DIŞ TİCARET, ÜRETİM, LOJİSTİK, YÖNETİM VE İDARI ORGANİZASYON FAALİYETLERİ

SUPPLY, PURCHASE, SALE OF IRON-STEEL SEMI-PRODUCTS AND PRODUCTS, INCLUDING THESE ACTIVITIES RELATED CUSTOMS, FOREIGN TRADE, PRODUCTION, LOGISTICS, MANAGEMENT AND ADMINISTRATIVE ORGANIZATION ACTIVITIES

Sertifika İlk Yayın Tarihi / 04.02.2022
Certificate First Issue Date
Sertifika Yayın Tarihi / 04.02.2022
Certificate Release Date
Sertifika Revizyon No ve Tarihi / 00 / -
Certificate Revision Number and Date
Sertifika Geçerlilik Tarihi / 03.02.2023
Certificate Validity Date
Sertifika No / EMS-22-0402-INO
Certificate No
Belge Periyodu / 3 Yıl (Years)
Certificate Period



[Handwritten Signature]



KIOSCERT Belgelendirme Hizmetleri Ltd. Şti. / KIOSCERT Certification Services Ltd. Şti.
Kılıçlı Mah. 8738/3. Sokak No: 7 İç Kapı No: 2 Çifti / İzmir / Türkiye / Tel: 0232 230 00 00 / www.kioscert.com.tr / info@kioscert.com.tr
Certification services provided by KIOSCERT Certification Services Ltd. Şti.

CERTIFICATE



Bu Sertifika / This certificate is granted to the organization



INOVA STEEL DIŞ TİCARET LİMİTED ŞİRKETİ

Kılıçlı Çift Mah. 8738/3. Sokak No: 7 İç Kapı No: 2 Çifti / İzmir / Türkiye

KIOSCERT Belgelendirme tarafından denetlenmiş ve uygulanmakta olduğu Müşteri Memnuniyeti Yönetim Sistemleri
Is audited by KIOSCERT Certification and applied
Customer Satisfaction Management System meet the requirements of

ISO 10002:2018

standartlarına aşağıdaki kapsamda uymakta olduğu görülmüştür.
Standard for the following activities:

Belgelendirme Kapsamı / Certification Scope

DEMİR-ÇELİK YARI MAMÜL VE MAMÜLLERİN TEMİN EDİLMESİ, ALIMI, SATIMI, BU FAALİYETLERE İLİŞKİN GÜMRÜK, DIŞ TİCARET, ÜRETİM, LOJİSTİK, YÖNETİM VE İDARI ORGANİZASYON FAALİYETLERİ

SUPPLY, PURCHASE, SALE OF IRON-STEEL SEMI-PRODUCTS AND PRODUCTS, INCLUDING THESE ACTIVITIES RELATED CUSTOMS, FOREIGN TRADE, PRODUCTION, LOGISTICS, MANAGEMENT AND ADMINISTRATIVE ORGANIZATION ACTIVITIES

Sertifika İlk Yayın Tarihi / 04.02.2022
Certificate First Issue Date
Sertifika Yayın Tarihi / 04.02.2022
Certificate Release Date
Sertifika Revizyon No ve Tarihi / 00 / -
Certificate Revision Number and Date
Sertifika Geçerlilik Tarihi / 03.02.2023
Certificate Validity Date
Sertifika No / CSMS-22-0402-INO
Certificate No
Belge Periyodu / 3 Yıl (Years)
Certificate Period



[Handwritten Signature]



KIOSCERT Belgelendirme Hizmetleri Ltd. Şti. / KIOSCERT Certification Services Ltd. Şti.
Kılıçlı Mah. 8738/3. Sokak No: 7 İç Kapı No: 2 Çifti / İzmir / Türkiye / Tel: 0232 230 00 00 / www.kioscert.com.tr / info@kioscert.com.tr
Certification services provided by KIOSCERT Certification Services Ltd. Şti.

CERTIFICATE



Bu Sertifika / This certificate is granted to the organization



İNOVA STEEL DIŞ TİCARET LİMİTED ŞİRKETİ

Küçük Çiftlik Mah. 873A/1. Sokak No: 7 İç Kapı No: 2 Çiftlik / İznik / Türkiye

KIOSCERT Belgelendirme tarafından denetlenmiş ve uygulanmakta olduğu
Çevre Yönetim Sisteminin
Is audited by KIOSCERT Certification and applied
Environmental Management System meet the requirements of

ISO 14001:2015

standartlarına aşağıdaki kapsamda uymakta olduğu görülmüştür.
Standard for the following activities.

Belgelendirme Kapsamı / Certification Scope

DEMİR-ÇELİK YARI MAMÜL VE MAMÜLLERİN TEMİN EDİLMESİ, ALIMI, SATIMI, BU FAALİYETLERE
İLİŞKİN GÜMRÜK, DIŞ TİCARET, ÜRETİM, LOJİSTİK, YÖNETİM VE İDARI ORGANİZASYON FAALİYETLERİ

SUPPLY, PURCHASE, SALE OF IRON-STEEL SEMI-PRODUCTS AND PRODUCTS, INCLUDING THESE
ACTIVITIES RELATED CUSTOMS, FOREIGN TRADE, PRODUCTION, LOGISTICS, MANAGEMENT AND
ADMINISTRATIVE ORGANIZATION ACTIVITIES

Sertifika İlk Yayın Tarihi / 04.02.2022

Certificate First Issue Date

Sertifika Yayın Tarihi / 04.02.2022

Certificate Release Date

Sertifika Revizyon No ve Tarihi / 00 / -

Certificate Revision Number and Date

Sertifika Geçerlilik Tarihi / 03.02.2023

Certificate Validity Date

Sertifika No / EMS-22-0402-INO

Certificate No

Belge Periyodu / 3 Yıl (Years)

Certificate Period



[Handwritten Signature]



KIOSCERT Belgelendirme, İZMİR ÜSİB Belgelendirme Merkezi ve Çiftlik Mahallesi/141 38
Küçük Çiftlik Mah. No: 7 İç Kapı No: 2 Çiftlik Mahallesi, İZMİR - Tel: 0212 273 28 81 - www.kioscert.com.tr / info@kioscert.com.tr
Sertifika No: EMS-22-0402-INO

CERTIFICATE



Bu Sertifika / This certificate is granted to the organization



İNOVA STEEL DIŞ TİCARET LİMİTED ŞİRKETİ

Küçük Çiftlik Mah. 873A/1. Sokak No: 7 İç Kapı No: 2 Çiftlik / İznik / Türkiye

KIOSCERT Belgelendirme tarafından denetlenmiş ve uygulanmakta olduğu
Müşteri Memnuniyeti Yönetim Sisteminin
Is audited by KIOSCERT Certification and applied
Customer Satisfaction Management System meet the requirements of

ISO 10002:2018

standartlarına aşağıdaki kapsamda uymakta olduğu görülmüştür.
Standard for the following activities.

Belgelendirme Kapsamı / Certification Scope

DEMİR-ÇELİK YARI MAMÜL VE MAMÜLLERİN TEMİN EDİLMESİ, ALIMI, SATIMI, BU FAALİYETLERE
İLİŞKİN GÜMRÜK, DIŞ TİCARET, ÜRETİM, LOJİSTİK, YÖNETİM VE İDARI ORGANİZASYON FAALİYETLERİ

SUPPLY, PURCHASE, SALE OF IRON-STEEL SEMI-PRODUCTS AND PRODUCTS, INCLUDING THESE
ACTIVITIES RELATED CUSTOMS, FOREIGN TRADE, PRODUCTION, LOGISTICS, MANAGEMENT AND
ADMINISTRATIVE ORGANIZATION ACTIVITIES

Sertifika İlk Yayın Tarihi / 04.02.2022

Certificate First Issue Date

Sertifika Yayın Tarihi / 04.02.2022

Certificate Release Date

Sertifika Revizyon No ve Tarihi / 00 / -

Certificate Revision Number and Date

Sertifika Geçerlilik Tarihi / 03.02.2023

Certificate Validity Date

Sertifika No / CSMS-22-0402-INO

Certificate No

Belge Periyodu / 3 Yıl (Years)

Certificate Period



[Handwritten Signature]



KIOSCERT Belgelendirme, İZMİR ÜSİB Belgelendirme Merkezi ve Çiftlik Mahallesi/141 38
Küçük Çiftlik Mah. No: 7 İç Kapı No: 2 Çiftlik Mahallesi, İZMİR - Tel: 0212 273 28 81 - www.kioscert.com.tr / info@kioscert.com.tr
Sertifika No: CSMS-22-0402-INO

CERTIFICATE



This Certificate / This certificate is granted to the organization



INOVA STEEL DIŞ TİCARET LİMİTED ŞİRKETİ

Küçük Çiftlik Mah. 8728/1, Sokak No: 7 İç Kapı No: 2 Çiğli / İzmir / Türkiye
 KIOSCERT Belgelendirme tarafından denetlenmiş ve uygulanan olduğu İş Sağlığı ve Güvenliği Yönetim Sisteminin
 İşletme ve Güvenlik Yönetim Sistemi
 Occupational and Safety Management System meets the requirements of

ISO 9001:2015

Standardına aşağıdaki kapsamda uymakta olduğu görülmüştür.
 Standard for the following activities:

Belgelendirme Kapsamı / Certification Scope
 DEMİR-ÇELİK YARI MAMÜL VE MAMÜLLERİN TEMİN EDİLMESİ, ALIRI, SATIMI, BU FAALİYETLERE İLİŞKİN GÜMRÜK, DIŞ TİCARET, ÜRETİM, LOJİSTİK, YÖNETİM VE İDARİ ORGANİZASYON FAALİYETLERİNİ

SUPPLY, PURCHASE, SALE OF IRON-STEEL SEMI-PRODUCTS AND PRODUCTS, INCLUDING THESE ACTIVITIES RELATED CUSTOMER, FOREIGN TRADE, PRODUCTION, LOGISTICS, MANAGEMENT AND ADMINISTRATIVE ORGANIZATION ACTIVITIES

Sertifika No: / HSKS-22-0402-TR0
 Certificate No / HSKS-22-0402-TR0
 Belge Periyodu / 3 Yıl (Years)
 Certificate Period



Printed on high quality paper with watermark and security features.
 Yüksek kaliteli kağıda, suya ve kimyasallara dayanıklıdır.

CERTIFICATE



This Certificate / This certificate is granted to the organization



INOVA STEEL DIŞ TİCARET LİMİTED ŞİRKETİ

Küçük Çiftlik Mah. 8728/1, Sokak No: 7 İç Kapı No: 2 Çiğli / İzmir / Türkiye

KIOSCERT Belgelendirme tarafından denetlenmiş ve uygulanan olduğu İş Sağlığı ve Güvenliği Yönetim Sisteminin
 İşletme ve Güvenlik Yönetim Sistemi
 Occupational and Safety Management System meet the requirements of

ISO 45001:2018

Standardına aşağıdaki kapsamda uymakta olduğu görülmüştür.
 Standard for the following activities:

Belgelendirme Kapsamı / Certification Scope
 DEMİR-ÇELİK YARI MAMÜL VE MAMÜLLERİN TEMİN EDİLMESİ, ALIRI, SATIMI, BU FAALİYETLERE İLİŞKİN GÜMRÜK, DIŞ TİCARET, ÜRETİM, LOJİSTİK, YÖNETİM VE İDARİ ORGANİZASYON FAALİYETLERİNİ

SUPPLY, PURCHASE, SALE OF IRON-STEEL SEMI-PRODUCTS AND PRODUCTS, INCLUDING THESE ACTIVITIES RELATED CUSTOMER, FOREIGN TRADE, PRODUCTION, LOGISTICS, MANAGEMENT AND ADMINISTRATIVE ORGANIZATION ACTIVITIES

Sertifika No: / HSKS-22-0402-TR0
 Certificate No / HSKS-22-0402-TR0
 Belge Periyodu / 3 Yıl (Years)
 Certificate Period





Global Iron and Steel Supplier

Export Address

Yali Dist. 6471 Str. Med Office No.27
Floor.7 Apt.12 Karsiyaka / Izmir
Türkiye

00 90 533 088 57 82 - 00 90 530 180 45 54

export@inovasteel.com.tr

www.inovasteel.com.tr